

Vinaera[®] **TRAVEL**
Portable Electric Wine Aerator

Easy 、 Fast 、 Effective 、 Time-Saving 、 Fun

Decanting is the key that “unlocks” the enjoyment of the full-bodied flavors of wine.
The decanting effect of a Vinaera Travel is the same as that of a traditional glass decanter.
Wines can be decanted instantly with one simple pressing of a button.

Dine out 、 Camping 、 Event 、 Party

World's **Smallest Portable** Electric Wine Aerator 150G

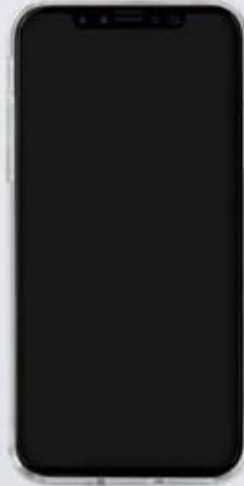

11cm



World's first Solenoid Valve Aerator

Innovative patented technology [Venturi Effect] + [Solenoid Valve] + [Powered Pneumatic Process] to wake up your wine as traditional decanter.
In addition, Vinaera Travel can prevent the wine reflux

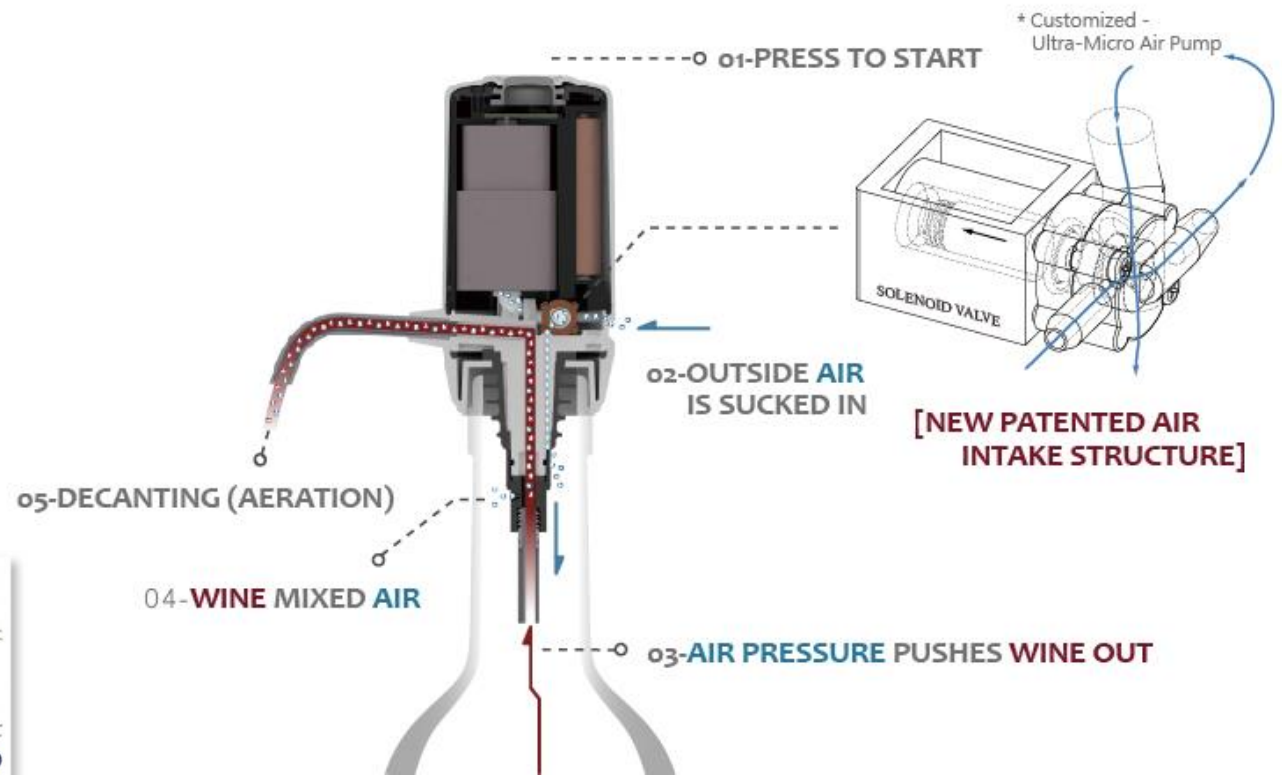

IPx6 waterproof – Easy



Vinaera Travel

Compatible with 80% table wine sold globally

Suitable for young wine aged 3-7 years

Aeration Effect is Equivalent to Around 45-60 minutes in a Glass Decanter

Just one touch, the wine is decanted immediately



各種酒類都適用~

威士忌

-降低辛辣-



紅酒

-消除單寧-









白酒

-打開酒香-



WINE TYPES SUITABLE FOR USE WITH THIS PRODUCT —

	Release Aroma	Aeration	Release Small Amounts of Fusel Alcohol	Reduce Harshness	Smoother Texture	Reduce Astringency	Other Features
 Red Wine	○	○	X	X	○	○	
 White Wine	○	N/A	X	X	○	X	
 Whisky	○	N/A	○	○	○	X	
 Brandy	○	N/A	○	○	○	X	
 Chinese White Wine	○	N/A	X	○	○	X	
 Other Distilled Liquor	○	N/A	X	○	○	X	
 Sparkling Wine	X	X	X	X	X	X	Don' t Use

* Most wine bottle mouths have an inner diameter of international standard (Inner diameter at 18.5mm). Few bottle mouths have a larger inner diameter that cannot be airtight, or a smaller inner diameter that does not fit installation, do not force installation on them in such cases.

* The wine aeration time and effect mentioned in this manual was obtained through testing by professionals with UK and US sommelier qualifications. Test results may vary depending on the sommelier and equipment.

Function Comparison

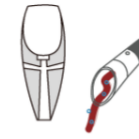

Description	The World' s First Adjustable Electric Wine Aerator	The World' s Smallest Portable Electric Wine Aerator	Acrylic / Plastic Aerator	Glass Decanter
Model	Vinaera PRO (MV7)	Vinaera Travel (MV63)	*Funnel Style Aerator *Aerator + Pouring	Traditional Glass Decanter
Principle	Venturi Effect + Adjustable Air Intake Mechanism 🏆	Venturi Effect + Solenoid Valve + Powered Pneumatic Process 🏆	Venturi Effect + Natural Air Intake	Shake Manually + Stand Still
Motor	Customized – Micro Water Pump 🏆	Customized – Ultra-Micro Air Pump 🏆	N/A	N/A
Save Decanting Time **	The Effect is About Decanting in a Decanter 0-180mins (Suitable for 99% Red Wines) 🏆	The Effect is About Decanting in a Decanter 45-60mins (Suitable for 80% Red Wines) 🏆	The Effect is About Decanting in a Decanter 10-20mins (Suitable for Very Few Red Wines)	N/A
Single Mode / Adjustable Aeration Level	Adjustable Aeration Level 🏆	Single Mode 🏆	N/A	N/A
Suitable for Bottle Size	0.75L/1.5L 🏆	0.75L 🏆	N/A	N/A
Drive Mode	AAA 1.5V x 6	AAA 1.5V x 4	Manual Mode	Manual Mode
The Bottles that can be used continuously (New Batteries)	100 Bottles 🏆	40 Bottles (Alkaline battery)	N/A	N/A
Clean Method	Cycle Cleaning 🏆	Waterproof 🏆	Washable 🏆	Washable (Fragile)
Water Resistance	Medium 🏆	O(IPX6) 🏆	O	O
Dispensing Function	O 🏆	O 🏆	X	X
Filter Function	O 🏆	X	O 🏆	X
Product Base	O 🏆	X	X	X
Carrying Case	X	O 🏆	X	X
Patent	O 🏆	O 🏆>	X	X
Use Situation	Home Use (Professional)	Party / Picnic / Camping	N/A	Home Use
Applicability liquor	Red Wine / White Wine / Whisky / Brandy / Chinese White Wine / Other Distilled Liquor	Red Wine / White Wine / Some Whisky & Brandy / Chinese White Wine Other Distilled Liquor	Red Wine / White Wine	Red Wine / White Wine

Traditional “Decanting” Is A Hassle, Now Vinaera Travel Makes It More Convenient For You!



IPx6 grade
waterproof



One touch
Instant decanting



Save 45-60mins of
decanting time



Use air to mix
wine oxidation

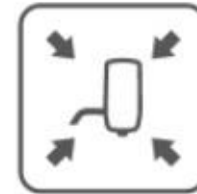

The world's
smallest



Lightest / 125g



Easy to cleaning



Easy to carry



Dispensed directly
into the glass

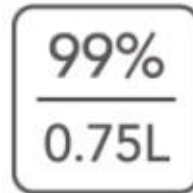

Suitable for 99%
of 0.75l bottles



Suitable for
different wines



More than 40 bottles
(Alkaline battery)

Four colors to choose



WHITE



BLUE



RED



BLACK

Specification

Name : Vinaera Portable Electric Wine Aerator

Type or Model : Vinaera Travel – MV63W, MV63BK, MV63R, MV63B

Brand Owner : Mercuries Asia Ltd.

Website : www.vinaera-global.com

Weight : 125g

Main Bod: L95.5mm x W47.5mm x H109.5mm

Telescoping Stainless Tube : L127~265mm

Color / Finish : White, Black, Red, Blue / Glossy

Material : ABS, Silicone Rubber, Stainless, Pump, Solenoid Valve

Power / Voltage / Current : 1.8W / 6V / 300mA

Country of Original : Design in Taiwan / Made in China (Taiwanese owner factory)

Certification : RoHS, CE, JFSL, FCC, FDA (Food Safe), IPX6, GB4706.1 2005

This product can be used with 99% red wine bottles. (May not be compatible with wine bottles that have unusual mouth diameters or shapes)

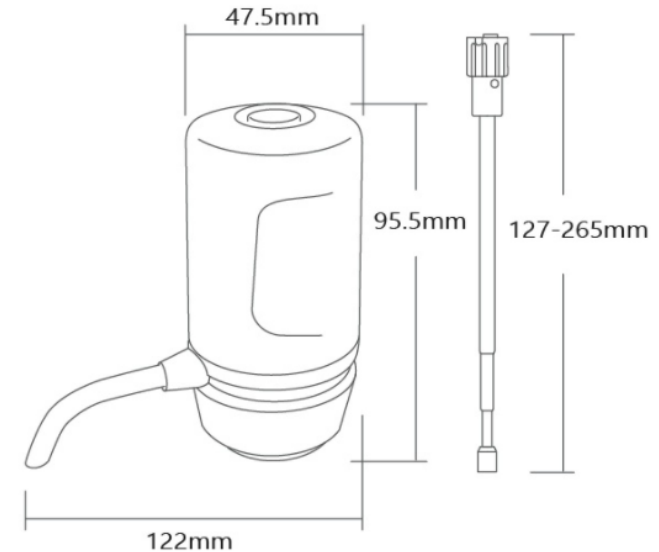

Vinaera[®] TRAVEL
Portable Electric Wine Aerator

