

Vinaera[®] PRO

Adjustable Electric Wine Aerator

THE WORLD'S FIRST
ADJUSTABLE ELECTRIC
WINE AERATOR

INNOVATION IN TRADITIONAL DECANTING



GOOD
DESIGN
AWARD
2017





Just One touch

Decant your wine immediately, save your time and energy

Patented design gives the freedom to decide the aeration time which best suits your taste by turning a dial instantly

Easy 、 Fast 、 Effective 、 Time-Saving 、 Fun

Same effect as a decanter with instant aeration and the level of your choice.

This innovation design can let the consumer decide the aeration time that best suits their taste, instantly with the turn of a dial.

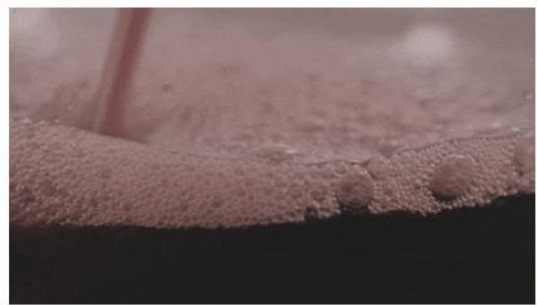

PRINCIPLES

[Adjustable Air Intake Mechanism] +
[Venturi Effect]

PATENTED DESIGN

Just one tap for aerating wine immediately at the aeration level of your choice

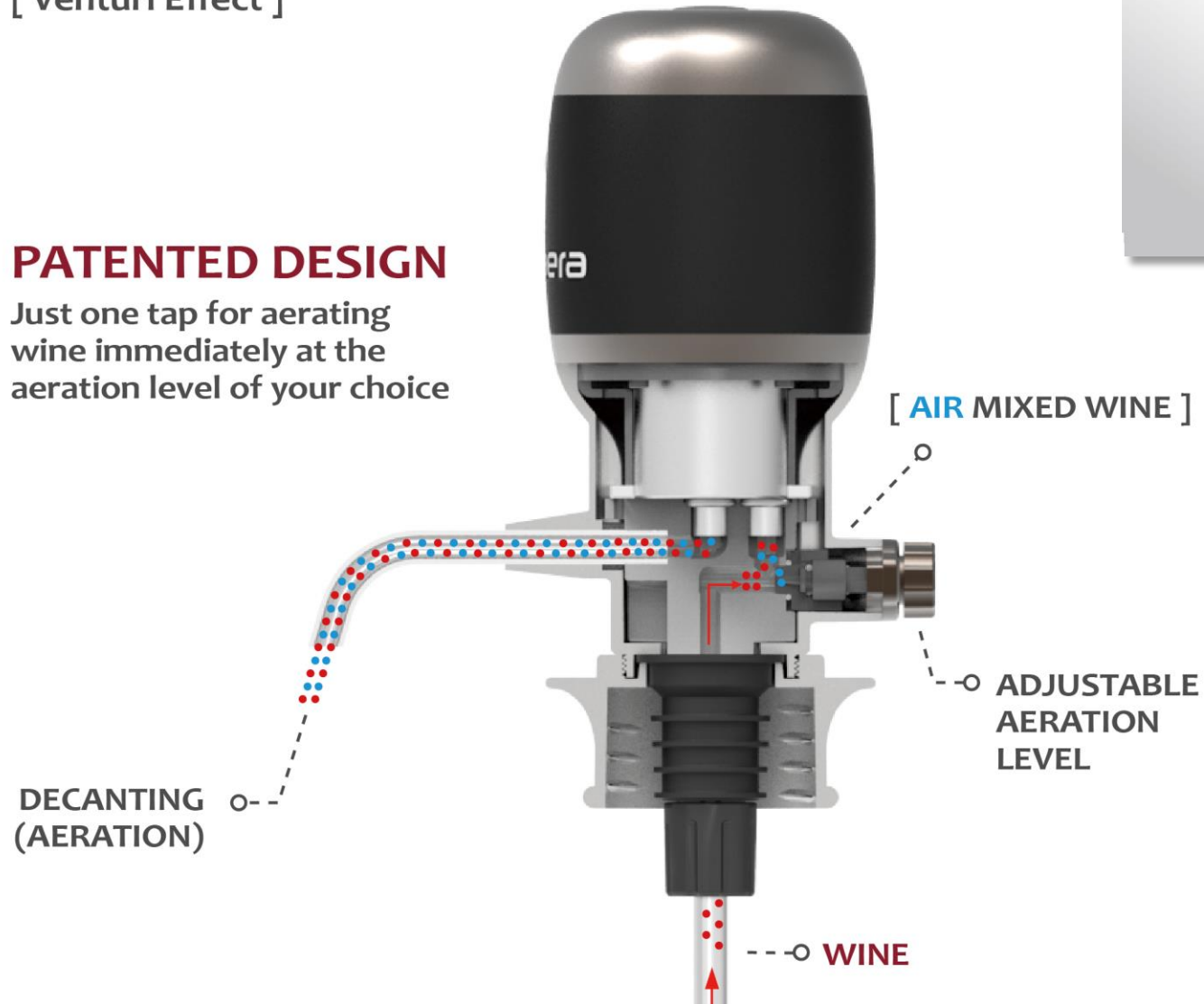

AERATION LEVEL GUIDELINES

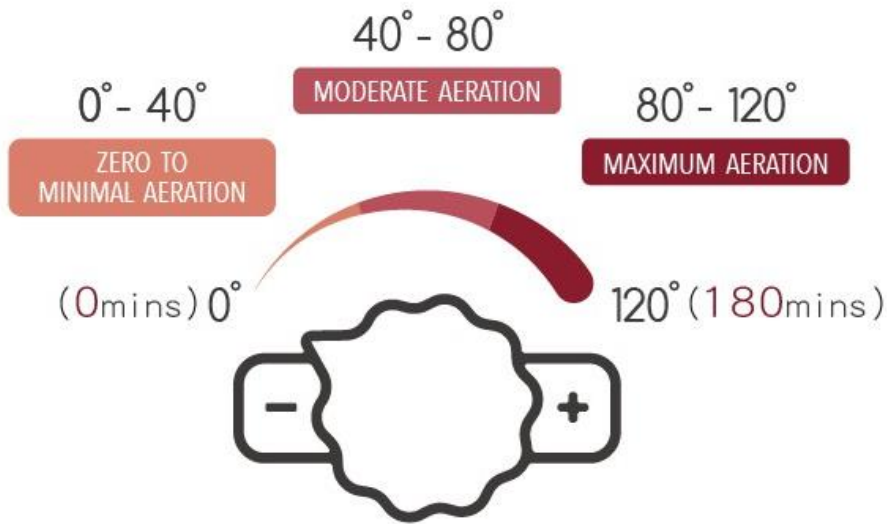

- Wine that require no aeration like most whites and light bodied reds.
- Most reds, and a few whites will land somewhere in this range, turn the dial to fit your specific tastes.
- This range works best with those super bold, super tannic red wines.

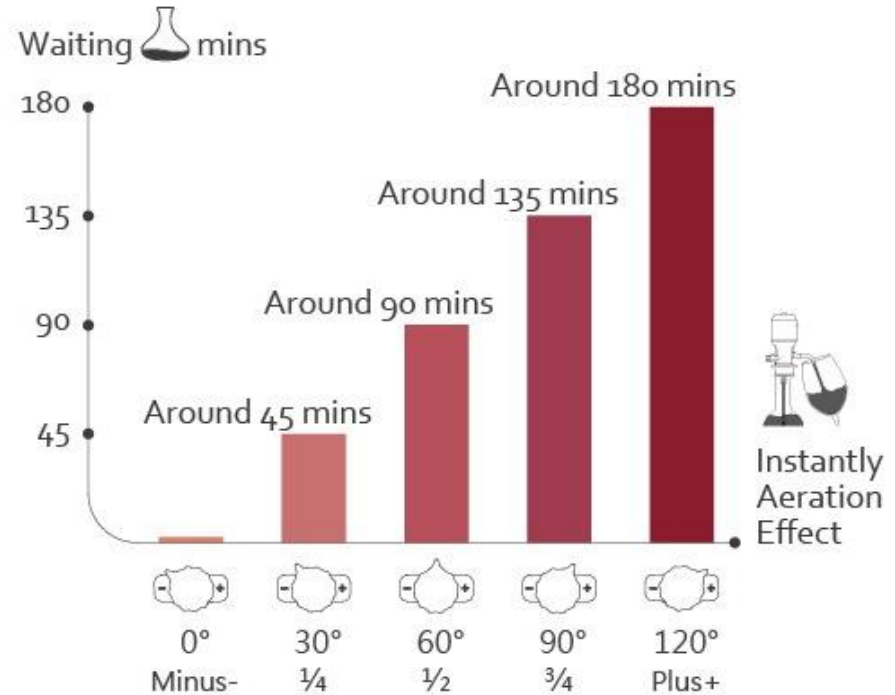

- We recommend adjusting your dial between the 1/4-1/3 position as a starting point for most wines. As a rule of thumb, most wines between 3-7 years old benefit from around 45-60 minutes in a decanter.
- The aeration time and effect was obtained through testing by professionals with UK and US sommelier qualifications.
- The tests compared the Vinaera PRO with conventional decanters found on the market.









**GOOD
DESIGN
AWARD
2017**



**THREE-STAGE TELESCOPING
TUBE CAN BE USED WITH
0.75L / 1.5L WINE BOTTLES**

SUITABLE FOR 99%+ WINE

	Release Aroma	Aeration	Release Small Amounts of Fusel Alcohol	Reduce Harshness	Smoother Texture	Reduce Astringency	Other Features
 Red Wine	O	O	N/A	N/A	O	N/A	
 White Wine	O	O	N/A	N/A	O	N/A	
 Whisky	O	N/A	O	O	O	N/A	
 Brandy	O	N/A	O	O	O	N/A	
 Chinese White Wine	O	N/A	N/A	O	O	N/A	
Other Distilled Liquor	O	N/A	N/A	O	O	N/A	
 Sparkling Wine	X	X	X	X	X	Don' t Use	

* An international standard applies to the internal diameter of wine bottle necks. This product cannot be used on other bottles with smaller necks.

Innovation in Traditional Decanting Wine

Vinaera PRO makes it quick and easy to get any wine tasting exactly how you want it so you can do just that.



Adjustable Aeration Function



Stainless-Steel Telescoping Tube is Suitable for 0.75/1.5L Wine Bottle

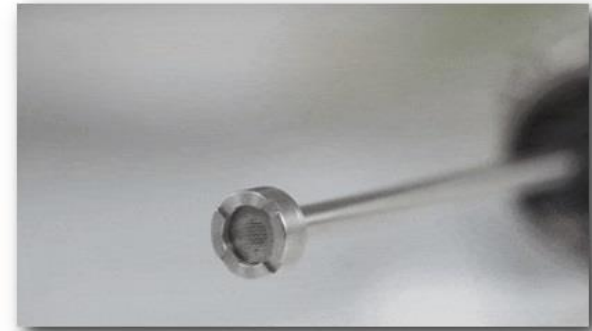

Built-in Sediment Filter



One-Touch Dispensing



Design for Assembly, Easy to Carry



Product Base

USE OCCASIONS

Open up for multilevel taste, enjoy different flavor at the same time
The best party tool for big group. Decant as many bottles as you need at once
No more waiting, just enjoy!!



Home Use



Friends Gathering



Restaurant



Outdoor Picnic



Sommelier Serving



Bar

SPECIFICATIONS

Brand : Vinaera

Name : Vinaera Pro – Adjustable Electric Wine Aerator

Type or Model: Vinaera Pro – MV7

Brand Owner: Mercuries Asia Ltd.

Website: vinaera-global.com

Weight: 220g

Main Body: L122mm x W57 mm x H148mm

Telescoping Stainless Tube: 135mm ~ 335mm

Color / Finish : Gunmetal Color / Nickel Plating

Material: ABS/ Silicone/ Stainless/ Pump

Power / Voltage / Current: 3.6V / 9V / 400mA

Country of Original : Design in Taiwan / Made in China

Six AAA 1.5V batteries are good for more than one hundred 750ml bottles of beverage.

This product can be used with 99% red wine bottles.

Certification : RoHS, CE, JFSL, FDA (Food Safe), GB4706.1 2005

Patent : TW Pat.M510918、CN Pat.ZL201620536912.5、CN Pat.ZL 201720116277.X、
CN Pat.ZL 201820391620.6、US Pat.9862590、Others : Patent Pending.



Vinaera[®] PRO
Adjustable Electric Wine Aerator

Popular among global wine lovers



For the wine connoisseur, Aervana takes wine tasting to a whole new level.

對紅酒鑑賞家來說，這項產品將「品酒」推向了一個全新的境界

The fact of the matter is, even if it didn't aerate the wine, the Aervana would still be extremely cool..But Aervana does aerate the wine, and it makes a big difference.

就算不拿這項產品來醒酒，Vinaera (Aervana) 依然是很酷的產品，但重點是它有醒酒的功能！這就差很多了



This battery powered wonder uses a patented design to force the perfect amount of air into the wine...is it more fun to pour every wine from an electric tapon top of the bottle? We think it is!

這項電子產品藉由它的專利技術，將紅酒與空氣完美混合.....此外，我們也認為一個按鍵就能將紅酒倒出，讓品飲紅酒顯得更有樂趣

Unlike manual aerators, which require more work, Aervana's option takes the guesswork out of the process and serves up a perfect glass with ease.

不像傳統的醒酒壺，Vinaera (Aervana) 幫你省去猜測醒酒時間的步驟，簡單又輕鬆地給你一杯完美的紅酒